

















Teil Part		
A		1pc
B		5pcs
C		1pc
D		1pc
E		1pair
F	 m6*40	6pcs
G	 8*17*1.2	4pcs
H		1pc
I	 m6*35	4pcs
J	 8*20*2	3pcs
K		1pc
L	 M8x20	3pcs
M		1pc
N		1pc
O	 M6x20	2pcs
P	 5mm	1pc
Q	 4mm	1pc

1



2

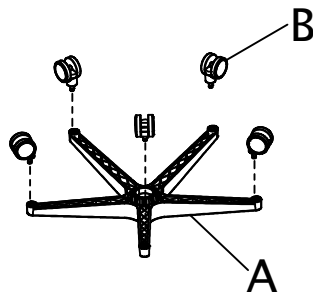
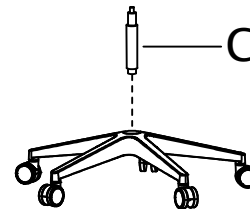

8

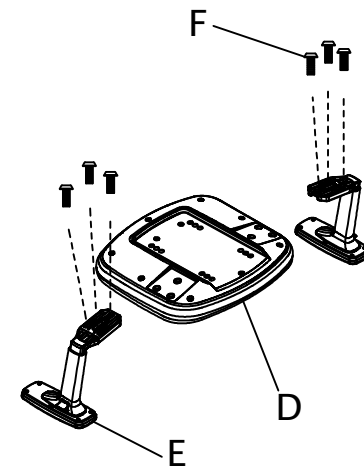

4

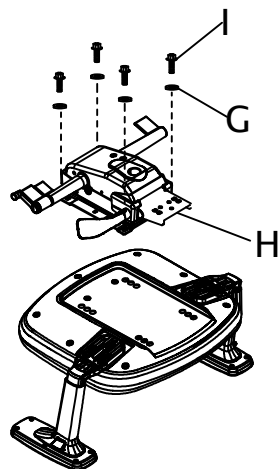

5

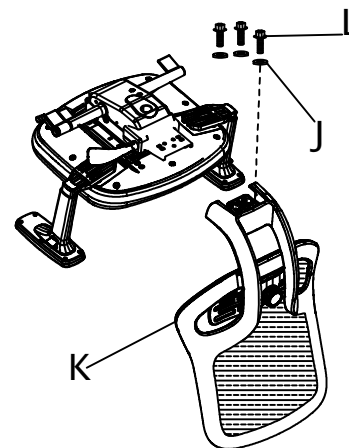

6

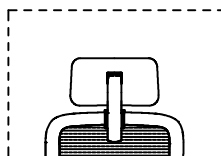
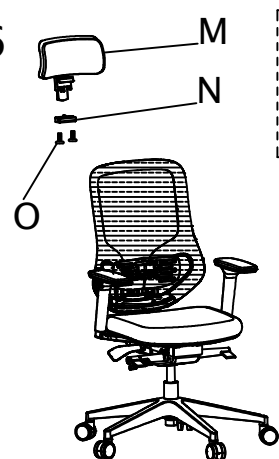

Bei der Installation der Kopfstütze achten Sie darauf, dass der Mechanismus oben (Kopfstütze in tiefster Position) ist um eine gerade Befestigung zu gewährleisten.

Please make shure to have the headrest in the lowest position during install to enshure a straight alignment.

7

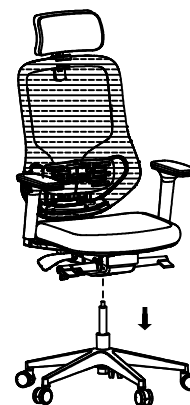

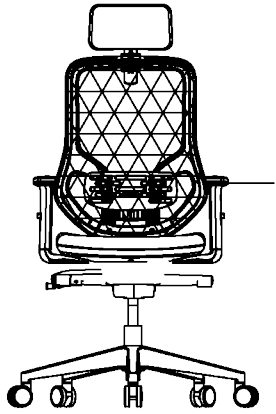

Armlehnen:
Höheneinstellung
Vor und Zurück
Einstellung
Winkel Einstellung

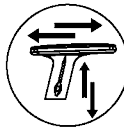

Armrest:
Height
adjustment
as well as
forward and
backward
adjustment
Angle adjustment

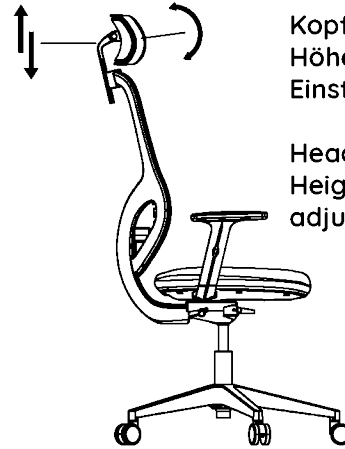
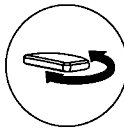

Kopfstütze:
Höhen und Winkel
Einstellung

Headrest:
Height and
angle
adjustment

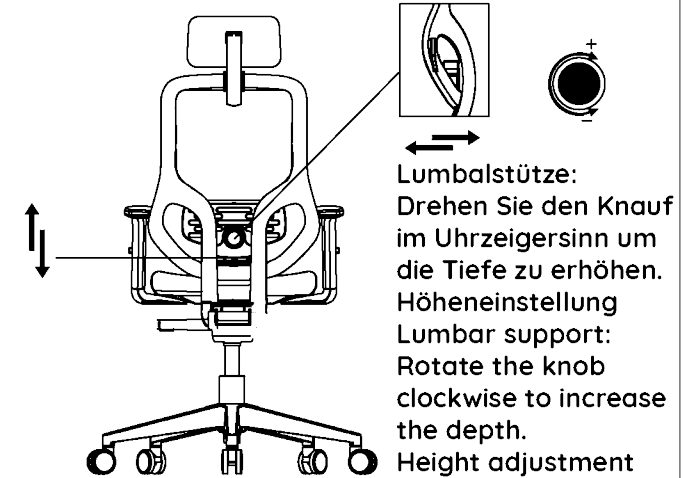

Lumbalstütze:
Drehen Sie den Knauf
im Uhrzeigersinn um
die Tiefe zu erhöhen.
Höheneinstellung
Lumbar support:
Rotate the knob
clockwise to increase
the depth.
Height adjustment

Drehen Sie den Griff im
Uhrzeigersinn um den Lehnen
Gegendruck zu erhöhen,
Turn the handle clockwise
for increased backrest
tension

Einstellung Sitzhöhe
Height adjustment

Schiebesitz
Seat slider

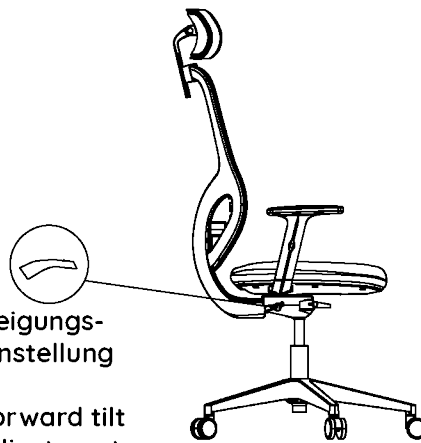
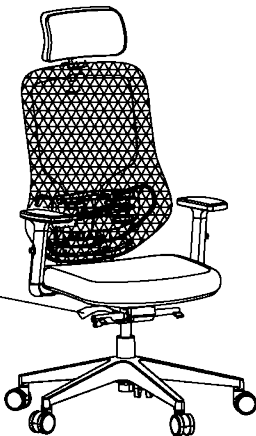

Neigungs-
einstellung
Forward tilt
adjustment



Neigung in 4
Positionen
feststellbar

Tilt lockable in
4 positions